

ELC40 Series

LOAD CONTROL MODULE FOR SSR170x RELAYS



INSTRUCTIONS FOR USE Ver. 06 (EN) – 06/24

EL.CO. S.r.l.

Via Lago di Molveno, 20
36015 SCHIO (VI) ITALY
TEL.: +39 0445 661722
FAX: +39 0445 661792

Website: <http://www.elco-italy.com>

INTRODUCTION



This manual contains the information required for proper installation and the instructions for use and maintenance of the product. It is therefore recommended to read it carefully and preserve it.

This publication is the exclusive property of EL.CO. S.R.L. that places the absolute

prohibition of reproduction and disclosure, even partial, if not expressly authorized.

EL.CO. S.R.L. reserves the right to make aesthetic and functional changes at any time and without notice.

If a malfunction or failure of the device can create hazardous or dangerous situations for people, animals or property, the system must be equipped with additional security devices.

EL.CO. S.R.L. and its legal representatives do not assume any responsibility for any damage to people, things or animals deriving from tampering, improper use, incorrect use or otherwise not complying with the device's features.

1 – DIMENSIONS (mm)

1.1 - ELCx40-x SERIES MODULE FOR MOUNTING IN SSR170x

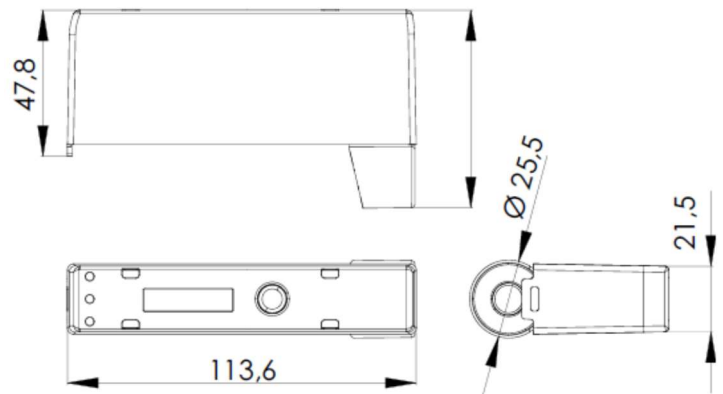

2 - DEVICE DESCRIPTION

2.1 - GENERAL DESCRIPTION

The ELC40 series are current monitoring devices for the SSR170H and SSR170 relays.

Thanks to this product, you can provide additional functionality to the relays of the SSR170H and SSR170 series.



This module can only be matched with DC input models relays (AS final code).

The range consists of 3 products:

- ELC40: Load current monitoring relay.
- ELC40-S: Load current monitoring relay with integrated MODBUS RTU RS485.
- ELCT40-S: Thermoregulator with integrated MODBUS RTU RS485.

3 - SMART-CONNECTION (for ELC40-S and ELCT40-S)

3.1 - PROGRAMMING FUNCTION

The smart-connection function allows you to program the products (ELC40-S and ELCT40-S models) via MODBUS RTU RS485.

The programming mode takes place through the 8-pole terminal located on the front of the product.

You can also use the ECD product by EL.CO. for programming.

For the configuration of the ELC40-S, it is not necessary to use the Modbus connection.

3.2 - PROGRAMMING VIA RS485 MODBUS (only for ELC40-S and ELCT40-S models)

3.2.1 - DESCRIPTION

The ELC40-S and ELCT40-S products can be programmed through software that uses the RS485 Modbus RTU protocol.

To keep the line at rest, the use of a termination resistor of 120 Ohm is required. The device does not mount this resistor. The termination of the RS485 line with the 120 Ohm resistor can be done through the terminal given as an accessory (see Paragraph 10.6).

The configurable communication speeds are from 1200 to 38400 baud. This allows for the wiring of the line using a medium quality shielded twisted pair: it is sufficient that the total capacity of the line does not exceed 200 nF.



The poll rate during programming and use must not be less than 50ms.

If more than 8 models are used, the recommended poll speed is greater than or equal to 80ms.



The maximum length of an RS485 transmission is 400 meters.

3.2.2 - DESCRIPTION OF THE COMMUNICATION PROTOCOL

The protocol used is MODBUS RTU. This choice guarantees ease of connection to many PLCs and to all commercial supervision programs.

The default MODBUS address is 100.

For those wishing to develop their own application software, all the necessary tips and information are available.

The MODBUS RTU protocol functions implemented in the ELCx40-S devices are:

- function 3 - reading of n words
- function 6 - writing a word

These functions (see Paragraph 7) allow the supervision program to read and edit any data of the module. Communication is based on messages sent by the master to the device.

The communication process involves two types of messages:

From the centralizer to the slave:

- Function 3: request to read n words
- Function 6: request to write a word

From the slave to the centralizer:

- Function 3: response containing n words read
- Function 6: confirmation of writing a word

Each message contains four fields:

- slave address: the values between 1 and 255 are valid; address 0 (zero) is reserved by MODBUS RTU for broadcasting messages, **but it is not adopted** in the ELCx40-S series due to the implicit unreliability of this type of communication;
- function code: it contains 3 or 6 depending on the specified function;
- information field: it contains the addresses or the value of the words, as required by the function used;
- control word: it contains a cyclic redundancy check (CRC) calculated according to the rules envisaged for CRC16.

The characteristics of asynchronous communication are: 8 bits, no parity, one stop bit.

The functions described for the RS485 protocol are found in Paragraph 7.

3.2.3 - DATA EXCHANGE

The data exchanged consist of a 16-bit word. All readable and writable data appear as 16-bit words allocated in the device's memory.

The operating and configuration parameters of the device can be read and written.

3.3 - PARAMETER READING VIA RS485 MODBUS

3.3.1 - DESCRIPTION

The ELCx40-S devices have both read and write parameters.

The parameters readable through RS485 are found in Paragraph 6.

4 - INSTALLATION AND USE WARNINGS

4.1 - PERMITTED USE



The device has been designed as a measurement and adjustment device in accordance with EN62314 for operation at altitudes up to 2000 m. The use of the device in applications not expressly provided for in the aforementioned standard must include all appropriate protective measures. The device CANNOT be used in hazardous (flammable or explosive) environments without proper protection. It should be remembered that the installer must ensure that the electromagnetic compatibility rules are respected even after the device has been installed, possibly using special filters. If a failure or malfunction of the device can create hazardous or dangerous situations for persons, animals or property, the system must be equipped with additional electromechanical devices to ensure safety.

4.2 - MECHANICAL ASSEMBLY

All models of the ELCx40-x series must be installed on SSR170x solid state relay. Avoid placing the device in places subject to high humidity or dirt that may cause condensation or the introduction of conductive parts or substances into the device. Ensure that the device has adequate ventilation and avoid installation in containers where devices are located that can lead the device to operate outside the declared temperature limits. Install the device as far as possible from sources that may generate electromagnetic disturbances such as motors, contactors, relays, solenoid valves etc.

An installation that does not comply with the provisions set out in this paragraph could compromise the declared protection levels.

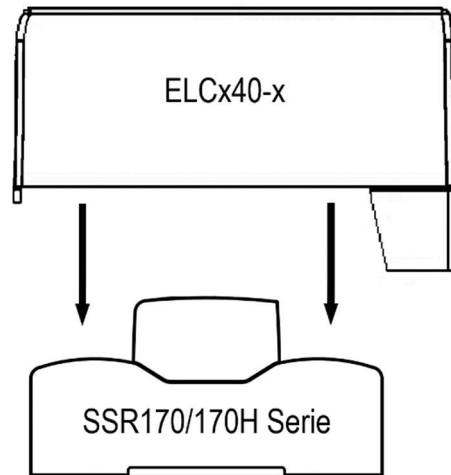

4.3 - WIRING DIAGRAM

4.3.1 - ELC40

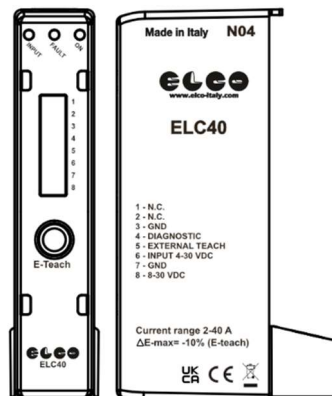

- 1) Not used
- 2) Not used
- 3) GND
- 4) Open-source error output 8...30VDC
- 5) Input for set current, active high 4...30VDC
- 6) Activation input, active high 4...30VDC
- 7) GND power supply
- 8) Power supply 8...30VDC

4.3.2 – ELC40-S

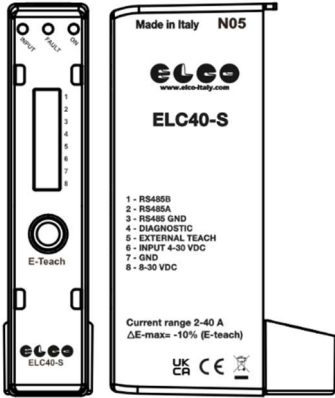

- 1) RS485 B
- 2) RS485 A
- 3) GND
- 4) Open-source error output 8...30VDC
- 5) Input for set current, active high 4...30VDC
- 6) Activation input, active high 4... 30VDC
- 7) GND power supply
- 8) Power supply 8... 30VDC

Through the button or with "external teach input", you can acquire the current that passes in that instant on the load. If the current is greater or less than 10% then the product will report an error.

The error is signaled through "diagnostic output", an 8...30VDC signal.

The LEDs in front will indicate the type of error.

LED table:

Explanation: A = LED off, E = LED on with constant light, B = Symmetrical flashing

	Input	ON	Fault
Powered product	B	A	A
Working product	E	E	A
Open Circuit	E	A	E
Overcurrent (> 10% E-Teach) *	E	E	B
Undercurrent (< 10% E-Teach) *	E	E	B
Short circuit of SSR	B	E	E

4.3.3 – ELCT40-S

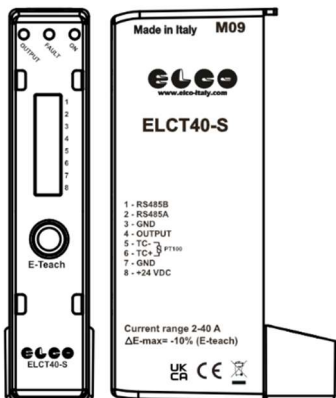

- 1) RS485 B
- 2) RS485 A
- 3) GND
- 4) Open-source error output 18...26VDC
- 5) Input - probe
- 6) Input + probe
- 7) GND power supply
- 8) Power supply 18... 26VDC

* with 2A E-Teach default value these error are not show

Only for the ELC40-S model, errors can be read from RS485 Modbus at address 0x64 with the following results:

- Stop 0x00
- Running 0x01
- No load present 0x02
- Overload 10% 0x03
- Underload 10% 0x04
- Short circuit of SSR 0x05

5.3 – ELCT40-S

Compared to ELC40-S, there is no external enable and teach input. The output to SSR170x is enabled only in thermoregulation mode with appropriate programming via Modbus. For the LED status refer to ELC40-x LED table.

5.3.1 - MEASUREMENT

The thermoregulator manages the following sensors that can be set from

“Probe type”: parameter: thermocouple of the J, K and PT100 type.

When changing this parameter, it is recommended to switch off and on the device again to obtain a correct measurement.

You can set the temperature unit of measurement (° C, ° F) using the “Meas. Unit” and the desired measurement resolution (0 = 1; 1 = 0.1) through the “Decimal value” (only for Pt100).

The device allows the calibration of the measurement, which can be used to recalibrate the device as needed of the application, through para. “Offset”. You can set a positive or negative offset that is simply added to the value read by the probe before displaying and resulting constant for all measures

5.3.2 - ON/OFF CONTROLLER

This control mode can be activated by setting the "Control" = on/off parameter. According to the measurement, the Setpoint, the operating mode and the programmed "P. hysteresis" and "N. hysteresis". The device performs an ON/OFF adjustment with asymmetric hysteresis. The controllers behave as follows: in the event of reverse action, or heating (“Func. OUT1”=heating), deactivate the output when the process value reaches the [SP + HPOS] value, to reactivate it when it falls below the [SP - HNEG] value. Vice versa, in case of direct action or cooling (“FUNC. OUT1”=cooling), they deactivate the output when the process value reaches the [SP - HNEG] value, to reactivate it when it rises above the [SP + POS] value.

4.4 - CONNECTION FROM ONE DEVICE TO ANOTHER DEVICE

The ELC40 series devices can be connected to each other through the terminal on the front



A device battery must consist of a maximum of 32 devices.

4.5 - TERMINAL BLOCK SPECIFICATIONS

- connection type: plug and push-in terminal block, spring loaded, 8 poles
- stripping length: 8 – 10 [mm]
- conductor section: 0.2 – 1.5[mm²] / 24 – 16 AWG

5 - OPERATION

5.1 - DESCRIPTION

The ELC40 series features current monitoring products. The ELC40-x products monitor the current and highlight errors. The ELCT40-S product, in addition to having the current monitoring function, also has thermoregulation functions.

5.2 - ELC40-x

The ELC40 product coupled with the SSR170x products allows you to control in order to have the diagnostics on the load. The product allows to intercept:

- Short circuit on the SSR
- Open circuit
- Overcurrent (+ 10% E-Teach (Paragraph 5.4))
- Undercurrent (-10% E-Teach (Paragraph 5.4))

The Overcurrent and Undercurrent errors can be detected as the product allows you to "learn" the current flowing through the load.

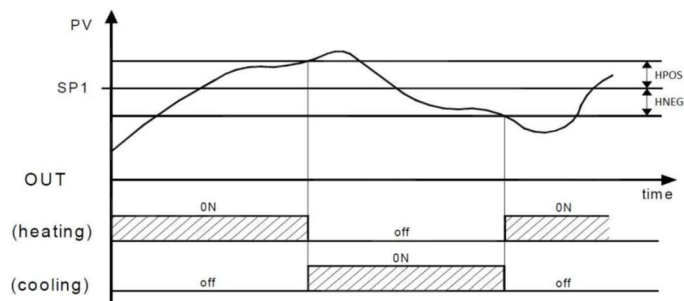

5.3.3 - NEUTRAL ZONE ON/OFF CONTROL

Neutral Zone operation is used to control systems that have an element that causes a positive increase (i.e., Heating, Humidifier, etc.) and an element that causes a Negative increase (i.e., Refrigerant, Dehumidifier, etc.).

This operation can be carried out when there are 2 outputs and it's obtained by programming the parameter "Control" = **DOUBLE ACTION**, the parameter "FUNC. OUT1" = **heating**, the parameter "Func. OUT2" = **cooling**.

The control operation acts on the outputs according to the measurement, of the Setpoint "Setpoint", and of the hysteresis "P Hysteresis" and "N Hysteresis" programmed.

The controller behaves as follows: it switches off the outputs when the process value reaches the setpoint and activates the **OUT1** output when the process value is lower than [Setpoint-N Hysteresis], or switches on the **OUT2** output when the process is greater than [Setpoint+P Hysteresis]. Consequently, the element causing the Positive increase must be connected to the **OUT1** output while the negative increase element must be connected to the **OUT2** output.

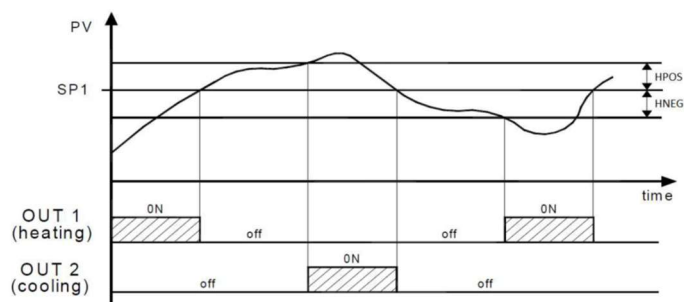

5.3.4 - PID CONTROLLER

The PID single action adjustment mode can be implemented by setting the parameter "Control" = **Pid** and acts on **OUT1** as a function of the "Setpoint".

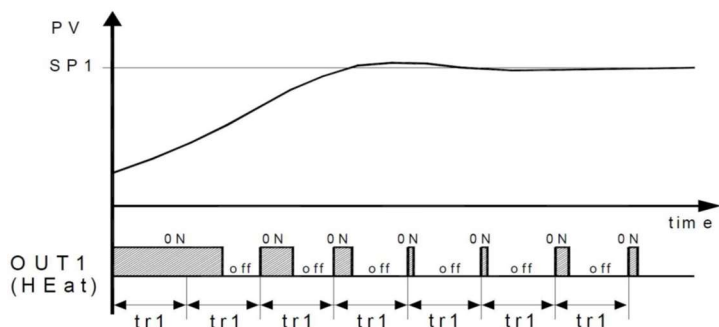

To obtain a good stability of the variable in fast processes, the "tr1" cycle time must have a low value with a very frequent intervention of the adjustment output. In this case, it is recommended to use a static relay (SSR) for the actuator control. The single-action PID adjustment algorithm provides the setting of the following parameters: "Prop. band", "Integral time", "Derivative T" and "T out".

5.3.5 - AUTOTUNING FUNCTION

The **AUTOTUNING** function provides for the calculation of the PID parameters through an **OSCILLATORY** type tuning cycle, after which the parameters are stored by the device and remain constant during

adjustment. The autotuning function automatically calculates the following parameters:

"Prop. band" - Proportional band

"Integral time" - Integral time

"Derivative T" - Derivative time

To enable the **AUTOTUNING** function, proceed as follows:

- 1) Set the desired "setpoint" setpoint.
- 2) Set the "Check" = **Pid** setpoint.
- 3) Set the "Func OUT1" parameter depending on the process to check through its output.
- 4) Set the "Autotun" parameter as:
 - = 1 - if you want autotuning to be started automatically every time the device is turned on.
 - = 2 - if you want autotuning to be started automatically when the device is next turned on and, when tuning is finished, it's automatically placed par. "Autotun"=0 (off).
- 7) Activate autotuning by turning the unit off and on again. The regulator then performs a series of connected system operations to calculate the most suitable PID adjustment parameters. The duration of the Autotuning cycle is limited to a maximum of 12 hours. In the event that the process is not completed within 12 hours, the parameters will not be changed and the value 0x06 will be read at the 0x64 address.

The values calculated by Autotuning will be automatically stored by the device at the end of the correct execution of the Autotuning cycle in the parameters relating to PID adjustment.

5.3.6 - ALARM FUNCTION

In the adjustment modes, you can activate alarms of relative minimum value, relative maximum value, absolute minimum value, absolute maximum value, relative value of active band within band, relative value of active band out of band.

You can enter a hysteresis and a delay on the return of the alarm. Such functions may be useful in order to avoid frequent interventions of the outputs especially when they command compressors. The delay function is deactivated by programming "Delay ALL1"(AL1D) on 0. The parameter "SP ALL1"(AL1) sets the alarm setpoint. "HYSTER ALL1"(AL1H) hysteresis.

Set "Func OUT2" = **ALARM** to associate output 2 with the alarm.

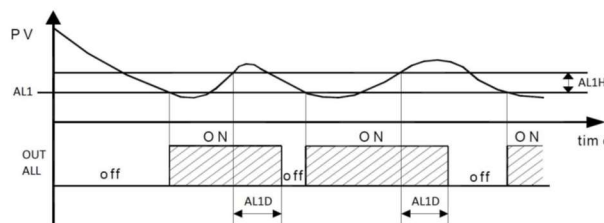

Operation example "FUNC ALL1" = **Loab** (minimum value alarm)

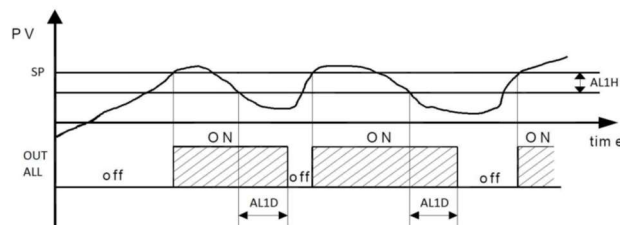

Example with "FUNC ALL1" = **HiEd** (relative maximum value alarm)

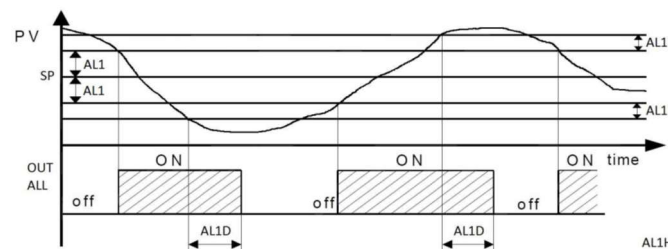

Example with "FUNC ALL1" = **LHdi** (relative band in alarm)

5.4 – E-Teach

The ELC40 series features an innovative system called **E-Teach**. The E-Teach system allows the device to record the instantaneous current in memory in order to capture the "Overcurrent" and "Undercurrent" error.

To save the instantaneous current, you can use 2 modes:

- Through the button: Press the button in front of the device for 6 seconds
- Through "External Teach" (only for ELC40 and ELC40-S): By giving a 4...30VDC signal in the "External Teach" terminal

Let's suppose that 20A passes into the TA. If I log the current, the device will save 20A in memory. If the device reads a value > 10% or <10% of the set value then it will report an error.

In the ELC40-S and ELCT40-S products, the device will also report the type of error via RS485.

The default value of the E-Teach is 2A and corresponds to no set limit.

5.5 - Smart DIP (for ELC40-S)

The ELC40-S product features "Smart DIP" technology. With this technology, you can set the Modbus address of the product and make the product plug-and-play and ready for use.

The address is set in binary in the dip switch from 1 to 5:

- xxx00000 -> The device can be configured via software and not via hardware. The Modbus default value is 100
- xxx00001 -> The device acquires address 1.
- xxx00010 -> The device acquires address 2.
-
- xxx11111 -> The device acquires address 31.

If configured via hardware, it will not be possible to configure the Modbus address via software. Hardware takes priority over software.

5.6 - Smart DIP (for ELCT40-S)

The ELCT40-S product features "Smart DIP" technology. With this technology, you can set the Modbus address of the product and/or the probe and make the product plug-and-play and ready for use.

The first 5 dips represent the Modbus address.

The 6,7 dips represent the selection of the probe and the regulation.

8 dip represents

The two divisions of dip are independent of each other.

The first 5 dips follow this rule (use xxx to indicate that 6,7 and 8 dips in the choice of the Modbus address are irrelevant):

- xxx00000 -> The device can be configured via software and not via hardware. The Modbus default value is 100
- xxx00001 -> The device acquires address 1.
- xxx00010 -> The device acquires address 2.
-
- xxx11111 -> The device acquires address 31.

6 and 7 dips follow this rule:

- x00xxxx -> The device can be configured via software and not via hardware. The default is TCJ probe
- x01xxxx -> TCJ
- x10xxxx -> TCK
- x11xxxx -> PT100

Since the dip blocks are independent, with this device I can:

- Keep everything at 0 and set via software
- Use the first 5 to change the Modbus address, but leave 6 and 7 dips at 0. In this way, the Modbus address is configured via hardware and the probes and adjustment via software

- Keep the first 5 dips at 0 and change the 6 and 7 dips. In this way I configure the Modbus address via software and the probes and adjustment via hardware.
- Change all dip switches setting everything via hardware

Hardware takes priority over software.

6 - PROGRAMMABLE PARAMETERS TABLE

All the parameters available on the device are described below.

RO: It indicates "Read Only"

RW: It indicates "Writing and Reading"

WO: It indicates "Write Only"

Product code parameters

Description		ELC40	ELC40-S	ELCT40-S	Hex-dec address
CP1 (RO)	1st field of the product code	E	E	E	0x01-1
CP2 (RO)	2nd field of the product code	L	L	L	0x02-2
CP3 (RO)	3rd field of the product code	C	C	C	0x03-3
CP4 (RO)	4th field of the product code	4	4	T	0x04-4
CP5 (RO)	5th field of the product code	0	0	4	0x05-5
CP6 (RO)	6th field of the product code		-	0	0x06-6
CP7 (RO)	6th field of the product code		S	-	0x07-7
CP8 (RO)	6th field of the product code			S	0x08-8

ELC40-S parameters

		Value range	Default	Hex-dec address
Current E-Teach (RW)	E-Teach saved current (A)	20 - 400	20	0x21 - 33
Address (RW)	Modbus address	1 - 255	100	0x22 - 34
Modbus speed (RW)	Modbus speed	1200 2400 9600 19200 38400	9600	0x23 - 35
Status/Err (RO)	Status or error	0 - 5	-	0x64 - 100
Current (RO)	Instantaneous current with decimal value	20 - 400	-	0x65 - 101

ELC40T-S parameters

		Value range	Default	Hex-dec address
Current E-Teach (RW)	E-Teach saved current (A)	20 - 400	20	0x21 - 33
Address (RW)	Modbus address	1 - 255	100	0x22 - 34

Modbus speed (RW)	Modbus speed	1200 2400 9600 19200 38400	9600	0x23 – 35
Setpoint (RW)	Temperature setpoint	-50°C – 1000°C	0	0x24 – 36
Probe type (RW)	TCJ, TCK, PT100	1=TCJ 2=TCK 3=PT100	1	0x25 – 37
Decimal value (RW)	Digits after the comma	0 - 1	0	0x26 – 38
Unit of measure (RW)	°C or °F	0=°C 1=°F	0	0x27 – 39
Offset (RW)	Offset on read temperature	-100 - +100	0	0x28 – 40
Check (RW)	Adjustment type	0=PiD 1=on/off 2=double action	0	0x29 – 41
Autotun. (RW)	Autotuning	0=disab. 1=start upon start-up 2=start upon every start-up	0	0x2A – 42
Pr. band (RW)	Proportional band	1 – 100	40	0x2B – 43
Int. time (RW)	Integral time	0 – 100	10.0	0x2C – 44
Der. time (RW)	Derivative time	0 – 50	5.0	0x2D – 45
Out time (RW)	Output time period	0.5 – 20.0 sec	20.0	0x2E – 46
P. hysteresis (RW)	Positive adjustment hysteresis	0 – 100	2	0x2F – 47
N. hysteresis (RW)	Negative adjustment hysteresis	0 - 100	2	0x30 – 48
Func. OUT1 (RW)	Operation mode OUT1	0=off 1=heating 2=cooling 3=ON	1	0x31 – 49
Func. OUT2 (RW)	Operation mode OUT2	0=off 1=heating 2=cooling 3=allarm 4=TA allarm 5=ON	0	0x32 – 50
Func. ALL1 (RW)	ALL1 operating mode	0=off 1 = absolute minimum value 2 = absolute maximum value 3 = relative minimum value 4 = relative maximum value 5 = relative band in 6 = relative band out	0	0x33 – 51
SP ALL1 (RW)	Alarm threshold AL1	-50 - 1000	0	0x34 – 52

Hyst. ALL1 (RW)	Hysteresis of alarm return ALH1	0 – 100	0	0x35 – 53
Delay ALL1 (RW)	Delay of alarm return AL1D	0 -100	0	0x36 – 54
Status/Err (RO)	Status or error	0 - 5	-	0x64 – 100
Current (RO)	Instantaneous current with decimal value	20 - 400	-	0x65 – 101
Temper. (RO)	Probe temperature	-50 - 1000	-	0x66 – 102

For the ELCx40-S models, you can reset the programming/configuration parameters to factory settings. Using Modbus write, the decimal value 9999 at address 0x64 (decimal 100).

7 - FUNCTIONS OF THE RS485 TRANSMISSION PROTOCOL

7.1 - FUNCTION 3 - READING N WORDS

The number of words to read must be less than or equal to twenty-eight.

The request has the following structure:

Number of the slave	Function number	Address of the first word		Number of words		CRC	
		MSB	LSB	MSB	LSB	MSB	LSB
byte 0	byte1=0x03	byte 2	byte 3	byte 4	byte 5	byte 6	byte 7

The response has the following structure:

Number of slave	Function number	NB Number of bytes read	Value of the first word		Subsequent words	CRC	
			MSB	LSB		MSB	LSB
byte 0	byte1=0x03	byte 2	byte 3	byte 4	byte 5	byte NB+2	byte NB+3

7.2 - FUNCTION 6 - WRITING A WORD

The request has the following structure:

Number of the slave	Function number	Address of the first word		Value to write		CRC	
		MSB	LSB	MSB	LSB	MSB	LSB
byte 0	byte1=0x06	byte 2	byte 3	byte 4	byte 5	byte 6	byte 7

The normal response is purely an echo of the request message:

Number of the slave	Function number	Address of the first word		Value to write		CRC	
		MSB	LSB	MSB	LSB	MSB	LSB
byte 0	byte1=0x06	byte 2	byte 3	byte 4	byte 5	byte 6	byte 7

7.3 - CYCLIC REDUNDANCY CHECK (CRC)

The CRC is a check word that allows you to verify the integrity of a message.

Each message, sent or received, contains the CRC word in the last two characters.

After receiving a request, the controller checks the validity of the message received, thus comparing the CRC contained in the message with the one calculated during reception.

During transmission, the controller calculates the CRC and places the two characters at the end of the message.

The calculation of the CRC is performed on each character of the message excluding the last two.

Since the devices are the ELCx40-S products compatible with the MODBUS RTU (JBUS) protocol, they use the same algorithm for the calculation of the CRC.

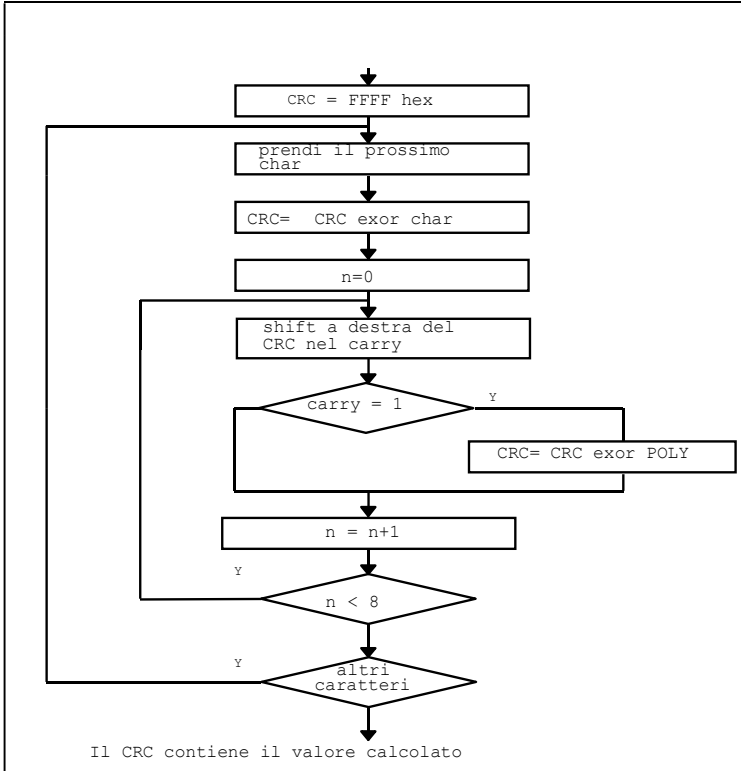

The polynomial adopted by MODBUS RTU (JBUS) is 1010 0000 0000 0001.

Note: the first character of the CRC transmitted is the less significant of the two calculated.

8.3 - FUNCTIONAL CHARACTERISTICS (for ELCT40-S)

Controller: ON/OFF, ON/OFF with neutral zone, single action PID.

Measurement range: view table 8.4

Total precision: +/- (1 % fs + 1 digit)

Sample timing: 170 ms

Maximum compensation error of cold junction (TC) : 1 °C/°C with ambient temperatura 0 ... 50 °C after warm-up (controller powerup) of 20 min.

Conformiy: Directive CEE EMC 89/336 (EN 61326), Directive CEE BT 73/23 e 93/68 (EN 61010-1).

Omologation: C-UL (file n. E206847)

8.4 - RANGE TABLE MEASUREMENT (for ELCT40-S)

INPUT	
TC J	-50 ... 1000°C
	-58 ... 1832 °F
TC K	-50 ... 1000°C
	-58 ... 1832 °F
PT100	-100 ... 400°C
	-148 ... 752 °F

8.5 - MECHANICAL CHARACTERISTICS

Container: Self-extinguishing plastic UL 94 V0

Dimensions: 114x70x23mm

Weight: 75g

Installation ELCx40-x series: on SSR170x

Connections: 8-pole removable push-in terminal

Front protection degree: IP 20

Pollution degree: 2

Use environment: indoor.

Working ambient temperature: -10+50°C

Working ambient humidity: 30+95 RH% without condensation

Temperature for the transportation and storage -30+80°C

8.6 - DEVICE CODING

ELC40 = Load current monitoring relay

ELC40-S = Load current monitoring relay with MODBUS RTU RS485

ELCT40-S = Thermoregulator with MODBUS RTU RS485 and load current monitor

MODBUS COMMUNICATION

Present for all ELC40-S and ELCT40-S models through the clamp placed in front of the product

9 - MAINTENANCE AND WARRANTY

9.1 - CLEANING

It is recommended to clean the device only with a slightly soaked cloth of water or non-abrasive detergent and not containing solvents.

9.2 - WARRANTY AND REPAIR

The device is guaranteed by manufacture defects or defects in material found within 12 months from the date of delivery.

Warranty is limited to repair or replacement of the product.

Possible opening of the container, tampering with the device, or improper use and installation of the product will automatically result in the warranty being decayed.

In the event of a defective product during the warranty period or outside the warranty period, contact the EL.CO. Sales Dept. to obtain authorization for shipment.

The defective product, therefore, accompanied by the indications of the defect found, must be sent to the EL.CO. unless otherwise agreed.

8 - TECHNICAL DATA

8.1 - ELECTRICAL FEATURES (for ELC40 and ELC40-S)

Power supply: 8...30 VDC,

Absorption: 3 W

Input/s: 2 inputs 4...30VDC

Outputs: 1 output for SSR170x, 1 open-source 8...30VDC output for feedback

Overtoltage category: 2

8.2 - ELECTRICAL FEATURES (for ELCT40-S)

Power supply: 18...26 VDC

Absorption: 1W

Input: 1 input for temperature probe: tc J,K ; RTD Pt 100 IEC.

Outputs: 1 output per SSR170X, 1 auxiliary output open-source 18...26VDC

Measurement category: I

Isolation: 1KV